

# EVALUATION OF CHECK SIZE IN GLUED LAMINATED TIMBER BEAMS



Number EWS R475E

May 2007

## INTRODUCTION

Wood swells or shrinks as it gains or loses moisture in response to changing relative humidity and temperature in the surrounding environment. If the moisture differential between the core and surface of the wood becomes great enough, the internal stresses associated with these dimensional changes can induce significant tensile stresses perpendicular to the grain. These stresses can result in “seasoning checks” developing across annual growth rings. This phenomenon is particularly pronounced in large, sawn-lumber beams.

In glued laminated timber (glulam), individual laminations are relatively thin (normally 1-3/8 to 1-1/2 inches) and therefore dry more uniformly. Also, the maximum moisture content of each lamination is limited to 16 percent or less for gluing purposes. As a result, seasoning checks occur less frequently in glulam than in sawn lumber.

It is important to distinguish seasoning checks in glulam from delamination, which results from inadequate glue bond between laminations. The key to identifying seasoning checks is the presence of torn wood fibers in the separation along the grain. Delamination is represented by a smooth lamination surface without torn wood fibers. Delamination is seldom observed in glulam members produced in accordance with the American National Standards Institute (ANSI) A190.1 standard for glulam. All APA glulam producing members certify their product meets the requirements of ANSI A190.1 by affixing the *APA EWS* trademark.

While delamination can occur at any of the gluelines between laminations, seasoning checks are often concentrated along the first glueline adjacent to an outer lamination (see Figure 1) but may occur anywhere on the surface of the member. Seasoning checks located at or near the first glueline are typically a result of environmental exposure to the large surface areas of the outer laminations.

FIGURE 1

### GLUED LAMINATED BEAM CROSS SECTION ILLUSTRATING CHECKING

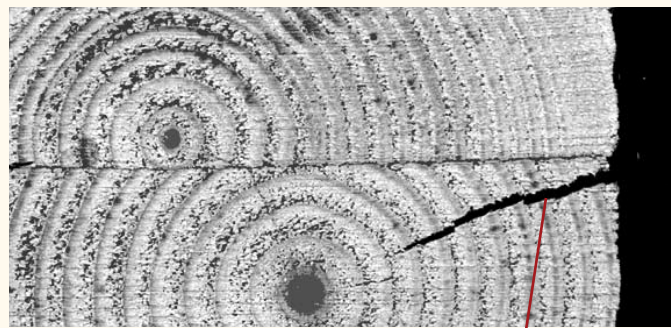

Seasoning check (uneven surfaces with torn wood fiber)

## EVALUATING CHECK SIZE IN GLULAM BENDING MEMBERS

For glulam bending members, the presence of seasoning checks generally affects only the horizontal shear capacity and usually is not significant outside the shear-critical zone. Bending and tensile strengths are virtually unaffected. The shear-critical zones, as shown in Figure 2, are typically defined as the areas at both ends of a simply supported timber beam within a distance from each end equal to three times the beam depth and within the middle 1/2 depth of the beam. For continuous beams, the shear-critical zone also includes a similar area over interior supports.

Traditionally, design values for horizontal shear stresses for glulam beams were determined using the principles set forth in ASTM D3737<sup>(3)</sup> and ASTM D245<sup>(1)</sup> using data given in ASTM D2555<sup>(2)</sup>. However, the current design values (see APA Design Specification, Y117) are based on the results of a series of tests conducted by APA – The Engineered Wood Association on full-size glulam beams<sup>(5)</sup>, which are applicable to glulam members having a rectangular cross section and subjected to typical building design loads of dead, live, snow, wind or earthquake, but do not specifically include the effects of seasoning checks.

To evaluate the effects of checks on the design shear stress of a glulam member, it is important to define checks. There are two types of checks: side checks and end checks (or splits), as shown in Figure 3. According to ASTM D245, the size of a side check is the average depth of separation measured from and perpendicular to the face on which it appears. End checks occur across the full width of the beam at the ends. The size of an end check is the average of lengthwise measurements made on both faces.

Based on years of performance history, practical experience, and full-scale shear tests with checks, the glulam industry has developed some “rules of thumb” to help evaluate the effect of checks on glulam shear capacity. The glulam industry has historically recommended no reduction in glulam shear capacity when a check, as measured and defined above, is no more than 15 percent of the beam width regardless of the checking location within the beam. This recommendation in general covers most seasoning checks found in glulam beams. A more specific recommendation based on full-scale beam tests with checks<sup>(6)</sup> is given in the APA publication: *Owner’s Guide to Understanding Checks in Glued Laminated Timber*, Form EWS F450.

FIGURE 2

### LOCATION OF THE SHEAR-CRITICAL ZONE AT END OF BALANCED LAYUP GLUED LAMINATED BEAM

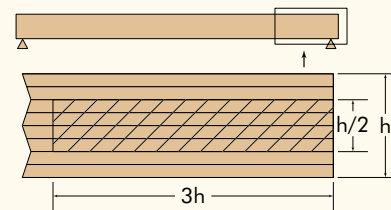
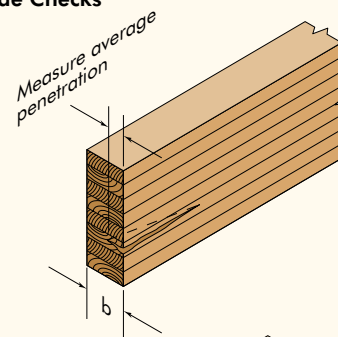

FIGURE 3

### SIDE CHECKS AND END SPLITS

#### Side Checks



#### End Splits

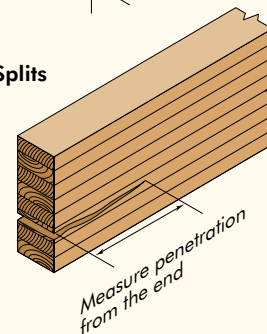

Some checking is of no structural concern, as described in the simple flow chart in Figure 4. This chart is in accordance with APA publication: *Owner's Guide to Understanding Checks in Glued Laminated Timber*, Form EWS F450. Refer to this flow chart prior to conducting an engineering analysis on the effect of checking, as covered in the following sections.

FIGURE 4

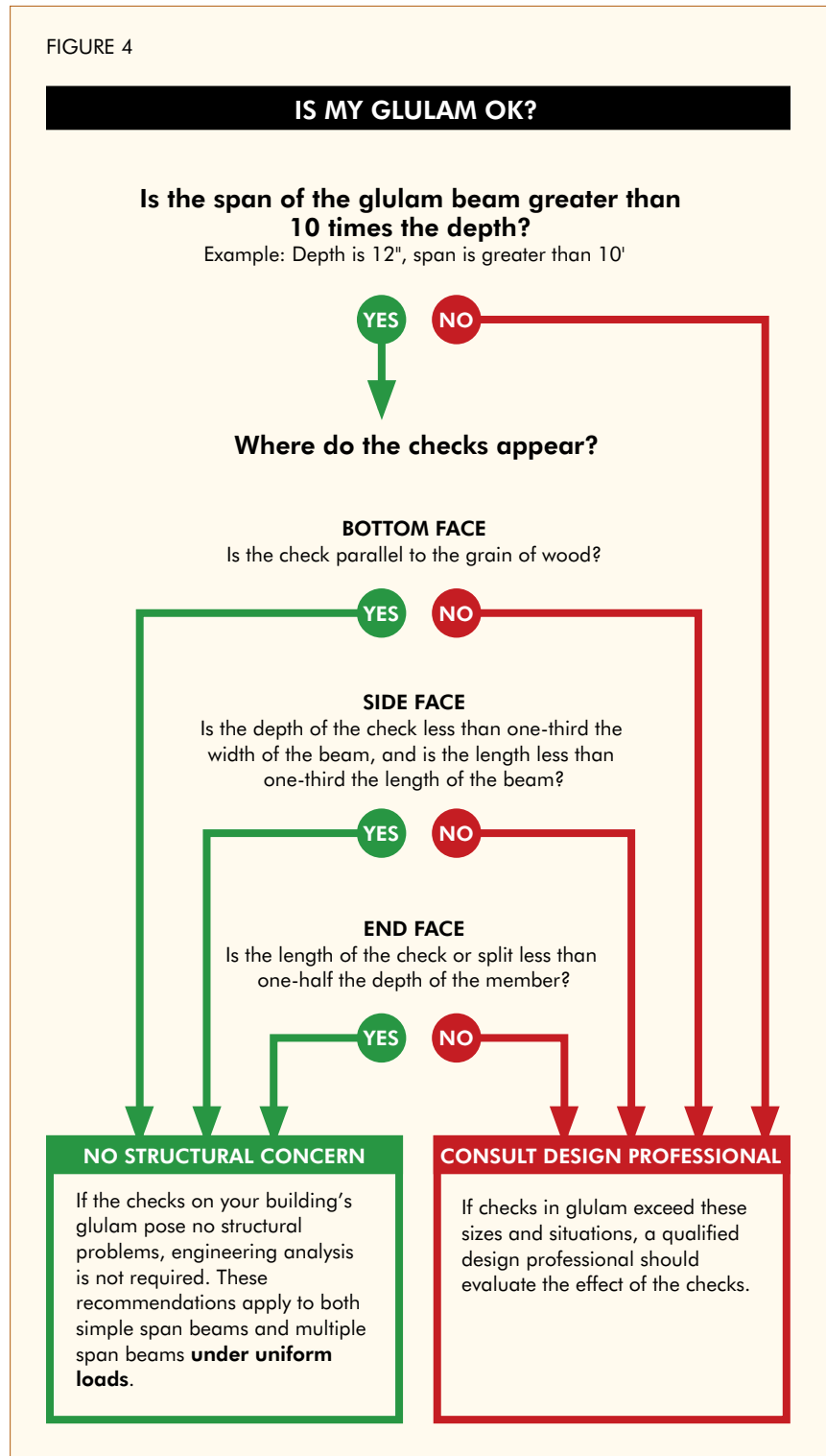

## ALLOWABLE CHECK SIZE

As mentioned previously, there is no reduction in glulam shear capacity with a check up to 15 percent of the beam width regardless of the checking location within the beam (including inside the shear-critical zone), as shown in Equations 1 and 2, and tabulated in Table 1 for various beam widths.

### Equation 1

Allowable side check depth inside the shear-critical zone (average depth measurement) =

$$SCD_{\text{Allow., inside}} = 0.15 \times b$$

### Equation 2

Allowable end check length inside the shear-critical zone (average length measurement) =

$$ECL_{\text{Allow., inside}} = 0.15 \times 3 \times b$$

where  $b$  is the glulam beam width, as shown in Figure 3.

When checks appear outside the shear-critical zone, the allowable check size may be determined in linear proportion to the shear-stress distribution in the beam. Figure 5 shows the theoretical and idealized shear-stress distributions (see Equation 4 for the definition of  $y/h$ ). According to the idealized shear-stress distribution, the allowable check size outside of the shear-critical zone (i.e., the shear stress ratio of less than 1.0) can be increased proportionally. For a typical glulam beam, Equations 3 and 4 may be used to determine the allowable size of checks located outside the shear-critical zone without the reduction in the glulam shear capacity. Table 2 shows results of these calculations for various beam widths. Refer to the report titled *Shear Stress in Two Wood Beams over Wood Block Supports*, published by U.S. Forest Products Laboratory<sup>(4)</sup>, for more detailed information.

TABLE 1

### ALLOWABLE CHECK SIZE INSIDE THE SHEAR-CRITICAL ZONE

Beam Width in Inches	Allowable Side Checks (Depth) in Inches	Allowable End Checks (Length) in Inches
2-1/2	3/8	1-1/8
3, 3-1/8, 3-1/2	1/2	1-1/2
5, 5-1/8, 5-1/2	3/4	2-1/4
6-3/4	1	3
8-1/2, 8-3/4	1-1/4	3-3/4
10-1/2, 10-3/4	1-1/2	4-1/2

TABLE 2

### ALLOWABLE CHECK SIZE OUTSIDE THE SHEAR-CRITICAL ZONE

Beam Width in Inches	Allowable Side Checks (Depth) in Inches				Allowable End Checks (Length) in Inches			
	y/h							
	0.30	0.35	0.40	0.45	0.30	0.35	0.40	0.45
2-1/2	3/4	1-1/4	1-5/8	2	2-3/8	3-5/8	5	6
3, 3-1/8	1	1-1/2	2	2-3/8	2-7/8	4-3/8	6	7-1/4
3-1/2	1-1/8	1-3/4	2-1/4	2-3/4	3-3/8	5-1/8	6-7/8	8-3/8
5, 5-1/8	1-5/8	2-1/2	3-1/4	4	4-3/4	7-3/8	9-7/8	12
5-1/2	1-3/4	2-3/4	3-5/8	4-3/8	5-1/4	8-1/8	10-7/8	13-1/4
6-3/4	2-1/8	3-1/4	4-1/2	5-3/8	6-1/2	9-7/8	13-3/8	16-1/4
8-1/2, 8-3/4	2-3/4	4-1/8	5-5/8	6-3/4	8-1/8	12-1/2	16-7/8	20-3/8
10-1/2, 10-3/4	3-3/8	5-1/8	6-7/8	8-3/8	10-1/8	15-3/8	20-3/4	25-1/4

**Equation 3**

Allowable side-check depth outside the shear-critical zone (average depth measurement) =

$$SCD_{\text{Allow., outside}} = C \times b$$

**Equation 4**

Allowable end-check length outside the shear-critical zone (average length measurement) =

$$ECL_{\text{Allow., outside}} = C \times 3 \times b$$

where

$$0.15 \leq C = 3.4 \left( \frac{y}{h} \right) - 0.7 \leq 0.8$$

$h$  = Glulam beam depth (height), in inches, and

$y$  = Distance away from mid-depth of the beam, in inches.

Figure 6 shows the allowable side-check size (depth) based on Equation 3. When comparing to Figure 5, it should be noted that an upper limit of 0.8 has been imposed on Figure 6 and Equation 3 as recommended by the glulam industry.

FIGURE 5

**THEORETICAL AND IDEALIZED SHEAR-STRESS DISTRIBUTIONS**

FIGURE 6

**ALLOWABLE SIDE-CHECK SIZE**

**EXAMPLE 1**

A side check with an average depth of 2 inches is located near the end and 1.5 inches up from the bottom face of a 5-1/8 x 24-inch x 18-foot simple-span 24F-V4/DF glulam beam (between the outer tension and adjacent laminations). The beam has no other strength-reducing characteristics at the check location and is subject to uniform load. Does this beam remain structurally sound?

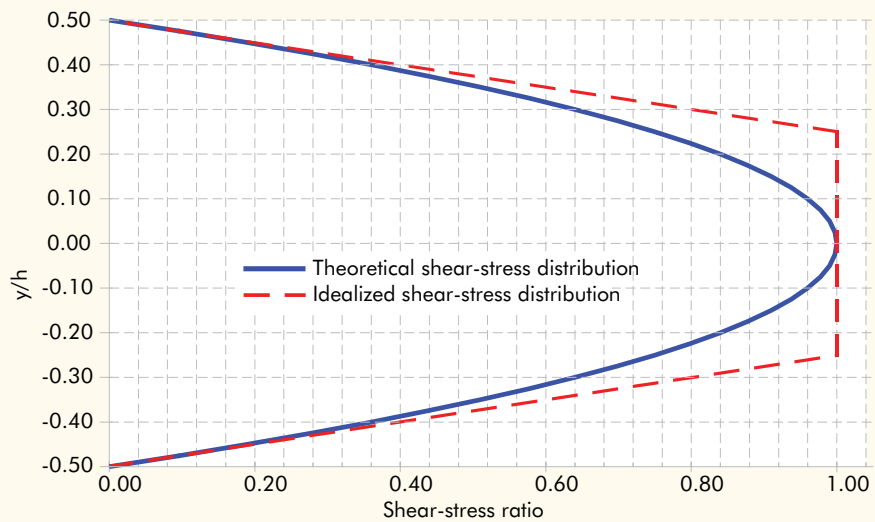
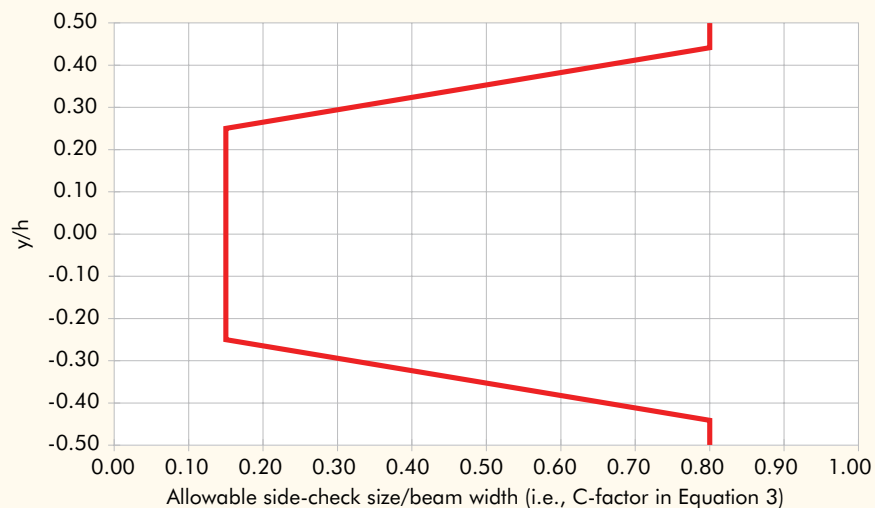
**Solution**

Since the span is less than 10 times the beam depth, an engineering analysis is performed below.

**Step 1**

Determine the location of the check as a percentage of the beam depth,  $\frac{y}{h}$ .

$$\frac{y}{h} = \frac{\left[\left(\frac{24}{2}\right) - 1.5\right]}{24} = 0.4375 > 0.25$$

Therefore, the check is located outside the shear-critical zone.

**Step 2**

According to Equation 3,

$$C = 3.4 \left(\frac{y}{h}\right) - 0.7 = 3.4 \times 0.4375 - 0.7 = 0.788 < 0.8$$

$$SCD_{\text{Allow., outside}} = C_c \times b = 0.788 \times 5.125 = 4.04" > 2.0". \text{ This check depth is acceptable.}$$

Or interpolating from Table 2, the allowable side check depth  $\cong 3.8$  inches .

**EXAMPLE 2**

The same situation as Example 1 except the check is located 7.5 inches up from bottom face of the beam.

**Solution****Step 1**

Determine the location of the check as a percentage of the beam depth,  $\frac{y}{h}$ .

$$\frac{y}{h} = \frac{\left[\left(\frac{24}{2}\right) - 7.5\right]}{24} = 0.1875 < 0.25$$

Therefore, the check is located inside the shear-critical zone.

**Step 2**

According to Equation 1,

$$SCD_{\text{Allow., inside}} = 0.15 \times b = 0.15 \times 5.125 = 0.77" < 2.0". \text{ This check depth is excessive.}$$

Or based on Table 1, the allowable side check depth  $\cong 0.75$  inches. Therefore, it is necessary to carefully re-examine the adequacy of shear capacity based on the actual loading conditions and the net dimensions of the beam before allowing for a side check of 2 inches in depth, as shown in the following section.

## EVALUATING CHECK SIZE WITH REDUCTION IN SHEAR CAPACITY

When the measured check exceeds the allowable check size given in Equations 1 through 4, the design shear stress of the glulam should be reduced by the  $R_{\text{check}}$  factor based on the following equations:

### Equation 5

For side checks,

$$R_{\text{check}} = \frac{1 - \frac{a}{b}}{1 - C} \leq 1.0$$

### Equation 6

For end checks,

$$R_{\text{check}} = \frac{1 - \frac{a}{3b}}{1 - C} \leq 1.0$$

where

a = measured check size, in inches

b = glulam beam width, in inches

C = C factor calculated from Equation 3 or 4 when the check is outside the shear-critical zone

= 0.15 when the check is within the shear-critical zone

The shear capacity of the glulam beam is adequate if the applied maximum shear stress in the cross section where the deep check is located is not greater than the allowable shear stress adjusted by all applicable adjustment factors and further reduced by the  $R_{\text{check}}$  factor given in Equation 5 or 6.

**EXAMPLE 3**

Assuming the same situation as Example 2, determine the  $R_{\text{check}}$  factor.

**Solution**

$$a = 2"; b = 5.125"$$

Since the check is located inside the shear-critical zone,  $C = 0.15$

$$\text{Therefore, } R_{\text{check}} = \frac{1 - \frac{2}{5.125}}{1 - 0.15} = 0.72 \leq 1.0$$

The allowable shear stress should be multiplied by 0.72 when determining if the structural capacity of the glulam beam remains adequate with a side check of 2 inches in depth.

**EXAMPLE 4**

Assume the same situation as Example 1 except for an end check of 13 inches in average length.

**Solution****Step 1**

$$\frac{y}{h} = \frac{\left[\left(\frac{24}{2}\right) - 1.5\right]}{24} = 0.4375 \text{ and the check is located outside the shear-critical zone.}$$

**Step 2**

According to Equation 4,

$$C = 3.4 \left(\frac{y}{h}\right) - 0.7 = 3.4 \times 0.4375 - 0.7 = 0.788 < 0.8$$

Allowable check length =  $ECL_{\text{Allow., outside}} = 0.788 \times 3 \times 5.125 = 12.11" < 13"$ . This check length is excessive.

**Step 3**

According to Equation 6,

$$a = 13"; b = 5.125"; C = 0.788$$

$$\text{Therefore, } R_{\text{check}} = \frac{1 - \frac{13}{3 \times 5.125}}{1 - 0.788} = 0.73 \leq 1.0$$

The allowable shear stress should be multiplied by 0.73 when determining if the structural capacity of the glulam beam remains adequate with an end check of 13 inches in length.



## DISCUSSION

Allowable check sizes discussed above are applicable to glued laminated timber used as bending members (beams). Checks occurring on the soffit or narrow face of a bending member loaded in the direction perpendicular to the wide face of the laminations should be of no structural concern as long as they run parallel to the grain of the wood. For compression members (columns), checks are generally not structurally significant unless they develop into a split, thereby increasing the length-to-depth ( $l/d$ ) ratio. In such a case, the load-carrying capacity of the column should be reduced based on the new  $l/d$  ratio. A detailed evaluation performed by a design professional knowledgeable in timber design may be needed to ensure the integrity of the structural members.

It is important to note that even though a check located outside the shear-critical zone can be relatively large without jeopardizing the structural safety of the glulam beam, such checking may be an indication of excessive humidity and temperature conditions in the surrounding environment. Therefore, the cause of the excessive checking should be identified and corrected to prevent further progression that might ultimately lead to a check which is structurally significant.

## REFERENCES

1. American Society for Testing and Materials. Standard practice for establishing structural grades and related allowable properties for visually graded lumber, ASTM D245, *Annual Book of ASTM Standards*, Philadelphia, PA, 1998.
2. American Society for Testing and Materials. Standard test methods for establishing clear wood strength values, ASTM D2555, *Annual Book of ASTM Standards*, Philadelphia, PA, 1998.
3. American Society for Testing and Materials. Standard test method for establishing stresses for structural glued laminated timber, ASTM D3737, *Annual Book of ASTM Standards*, Philadelphia, PA, 1998.
4. Cowan, W.C. Shear stress in two wood beams over wood block supports, *Report No. 2249*, Forest Products Laboratory, USDA, Madison, WI, 1962.
5. Yeh, B., Williamson, T. G., and O'Halloran, M. R., Shear Strength of Structural Glued Laminated Timber Based on Full-Size Flexure Tests, *Proceedings of the 1999 Pacific Timber Engineering Conference*, Rotorua, New Zealand, 1999.
6. Yeh, B., Williamson, T. G., and Martin, Z. Effect of Checking and Non-Glued Edge Joints on the Shear Strength of Structural Glued Laminated Timber Beams, *Proceedings of 39th International Council for Research and Innovation in Building and Construction (CIB), Working Commission W18 – Timber Structures*, Florence, Italy, 2006.

We have field representatives in many major U.S. cities and in Canada who can help answer questions involving APA trademarked products. For additional assistance in specifying engineered wood products, contact us:

**APA – THE ENGINEERED WOOD ASSOCIATION**

**HEADQUARTERS**

7011 So. 19th St. ▪ Tacoma, Washington 98466 ▪ (253) 565-6600 ▪ Fax: (253) 565-7265

[www.apawood.org](http://www.apawood.org)



**PRODUCT SUPPORT HELP DESK**

(253) 620-7400 ▪ E-mail Address: [help@apawood.org](mailto:help@apawood.org)

**DISCLAIMER**

*The information contained herein is based on APA – The Engineered Wood Association's continuing programs of laboratory testing, product research, and comprehensive field experience. Neither APA, nor its members make any warranty, expressed or implied, or assume any legal liability or responsibility for the use, application of, and/or reference to opinions, findings, conclusions, or recommendations included in this publication. Consult your local jurisdiction or design professional to assure compliance with code, construction, and performance requirements. Because APA has no control over quality of workmanship or the conditions under which engineered wood products are used, it cannot accept responsibility for product performance or designs as actually constructed.*

Form No. EWS R475E/Revised May 2007

